

Tiran SG TR Twin

Ceiling Recessed

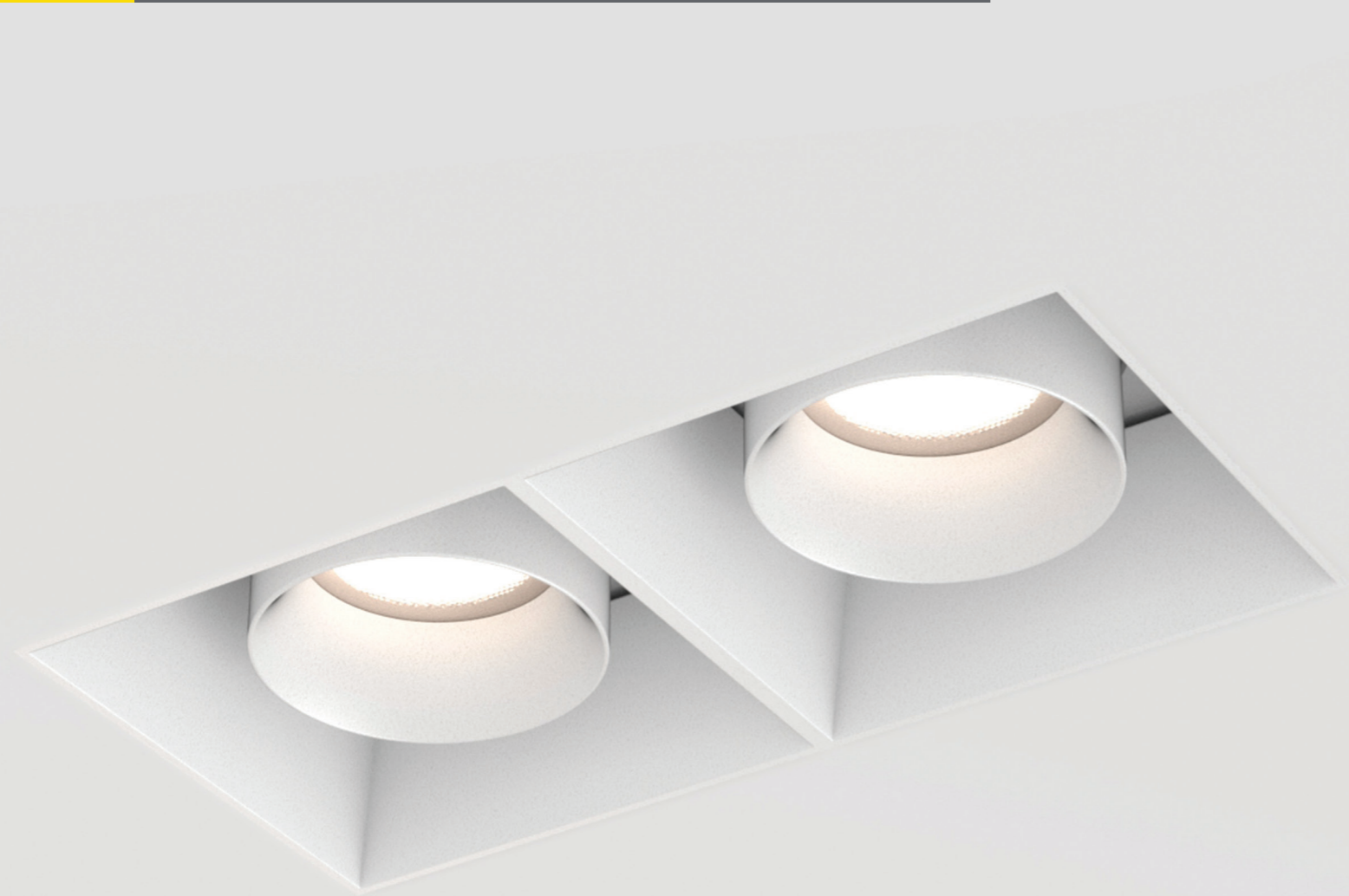

Tiran SG TR Twin

Ceiling Recessed

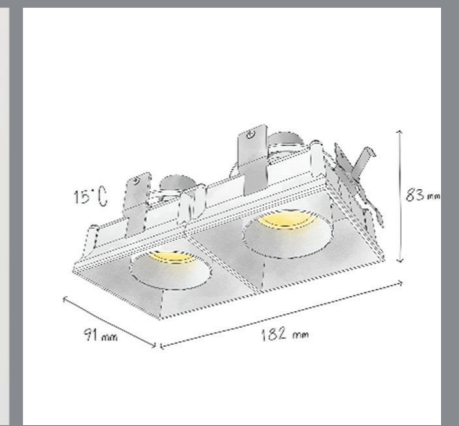
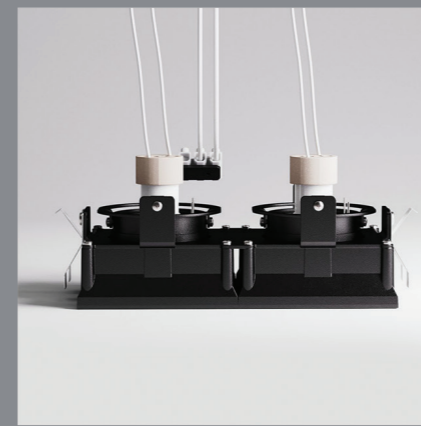
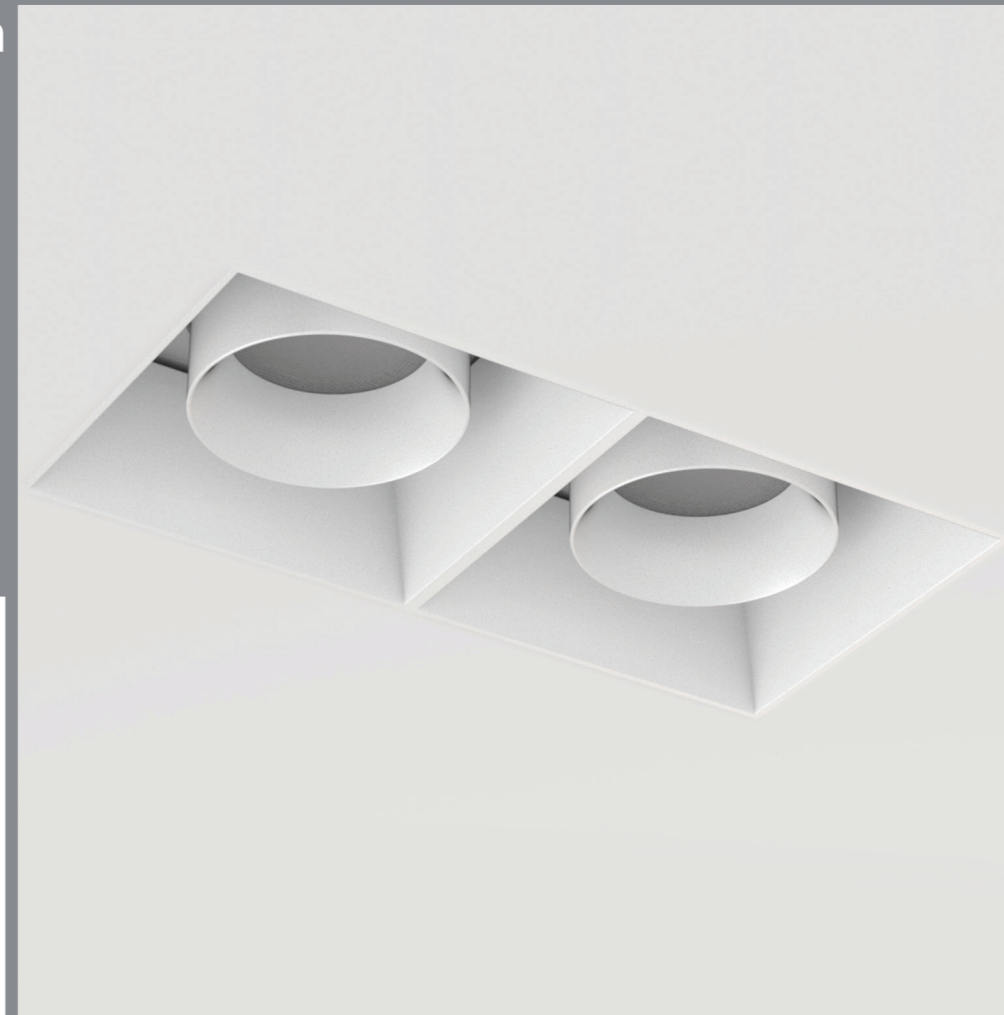

CODE	F116
Light source	LED
Power (W)	2 x 6
luminous flux (lm)	990
Color Rendering (Ra)	>80
Color Temperature (K)	3000 4000*
Body Color	White Black

*Customized body colors and other color temperatures (CCTs) are available upon request

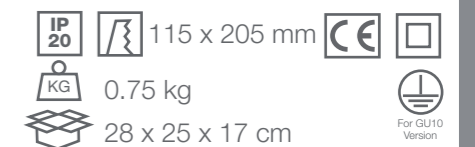

Supply Voltage:
220-240 Vac, 50Hz

Driver:
DALI | Dimmable version available upon request

Recommended Applications:
Residential | Office | Shop

Specific design of the bottom frame with its strips reduce the direct view to the light point and of course glare

Tiran SG TR Twin

Accessories

Mandatory

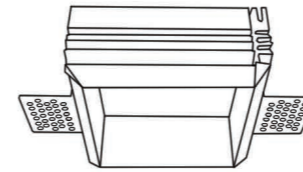

Trimless Installation Kit
Order code: 2099924118

Mandatory

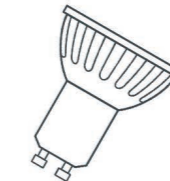

LED GU10 Lamp
Order code: 10020101

Order code table

Body Color	Order Code	Order Code	Body Color
White	F116WG	F116BG	Black

