

Sira V 1616

Linear Light



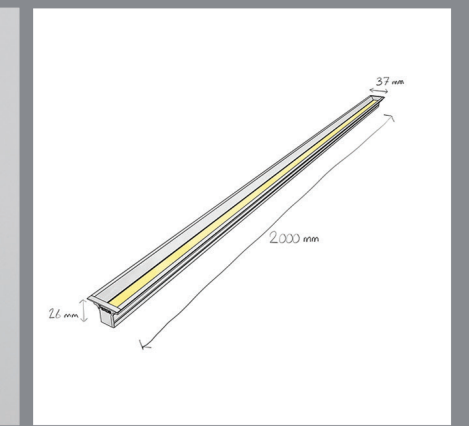

Sira V 1616

Linear Light



CODE	F463
Light source	LED
Power (W)	10
luminous flux (lm)	1100
Color Rendering (Ra)	>80
Color Temperature (K)	3000 4000
Body Color	White Black

IP 20  17 mm 
KG 0.29 kg/m
 1270 x 100 cm
Recommended Applications:
Residential | Office | Shop

*Customized body colors and other color temperatures (CCTs) are available upon request

Specific design of the bottom frame with its strips reduce the direct view to the light point and of course glare



Sira V 1616

Light distributions

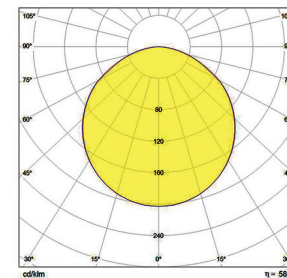

Wide (W)

Accessories

Recessed Installation

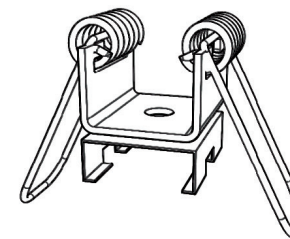

Sira V 1616 Bracket

Optional

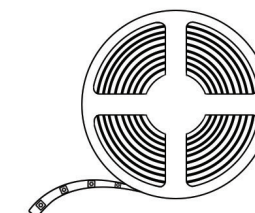

LED Strip
Refer to page 418

Order code table

Body Color	Order Code	Beam Angle	Order Code	Body Color
Wide	F463WW	Wide	F463BW	Black