

# Fitran Q TR Twin

Ceiling Recessed



## Fitran Q TR Twin Fitran QG TR Twin

\*for GU10 lamps





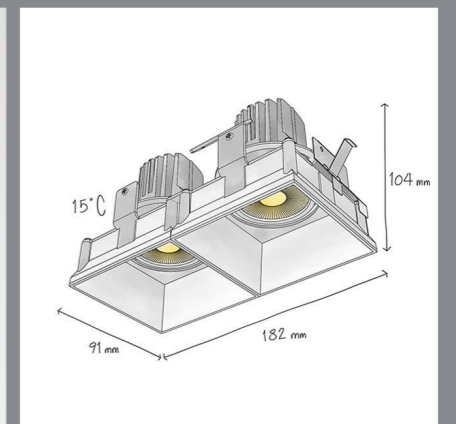



Ceiling Recessed



CODE	F117
Light source	LED
Power (W)	2x12
luminous flux (lm)	2600
Color Rendering (Ra)	>80
Color Temperature (K)	3000   4000*
Body Color	White   Black

\*Customized body colors and other color temperatures (CCTs) are available upon request

 115x205 mm
 
  
 1.82 kg  
 28 x 25 x 17 cm
 

**Supply Voltage:**  
220-240 Vac, 50Hz

**Driver:**  
DALI | Dimmable version available upon request

**Recommended Applications:**  
Residential | Office | Shop

Specific design of the bottom frame with its strips reduce the direct view to the light point and of course glare

## Fitran Q TR Twin

### Light distributions

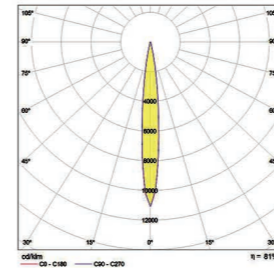

Spot(S)

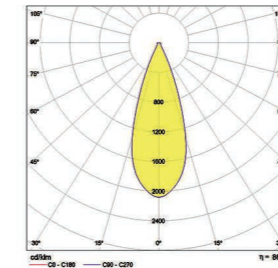

Medium(M)



### Accessories

#### Mandatory

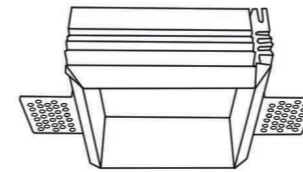

Trimless Installation Kit  
Order code: 2099924118

#### Optional

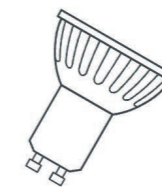

LED GU10 Lamp  
Order code: 10020101

### Order code table

Body Color	3000K ●	Beam Angle	4000K ●	Body Color
White	F116W1230S	Spot	F116W1240S	White
	F116W1230M	Medium	F116W1240M	

Body Color	3000K ●	Beam Angle	4000K ●	Body Color
Black	F116B1230S	Spot	F116B1240S	Black
	F116B1230M	Medium	F116B1240M	

### Order code for GU10 Version\*\*

Body Color	Body Code	Body Code	Body Color
White	F116WG	F116BG	Black

\*\*Lamp is not Included