

Sira P 4090

Linear Light

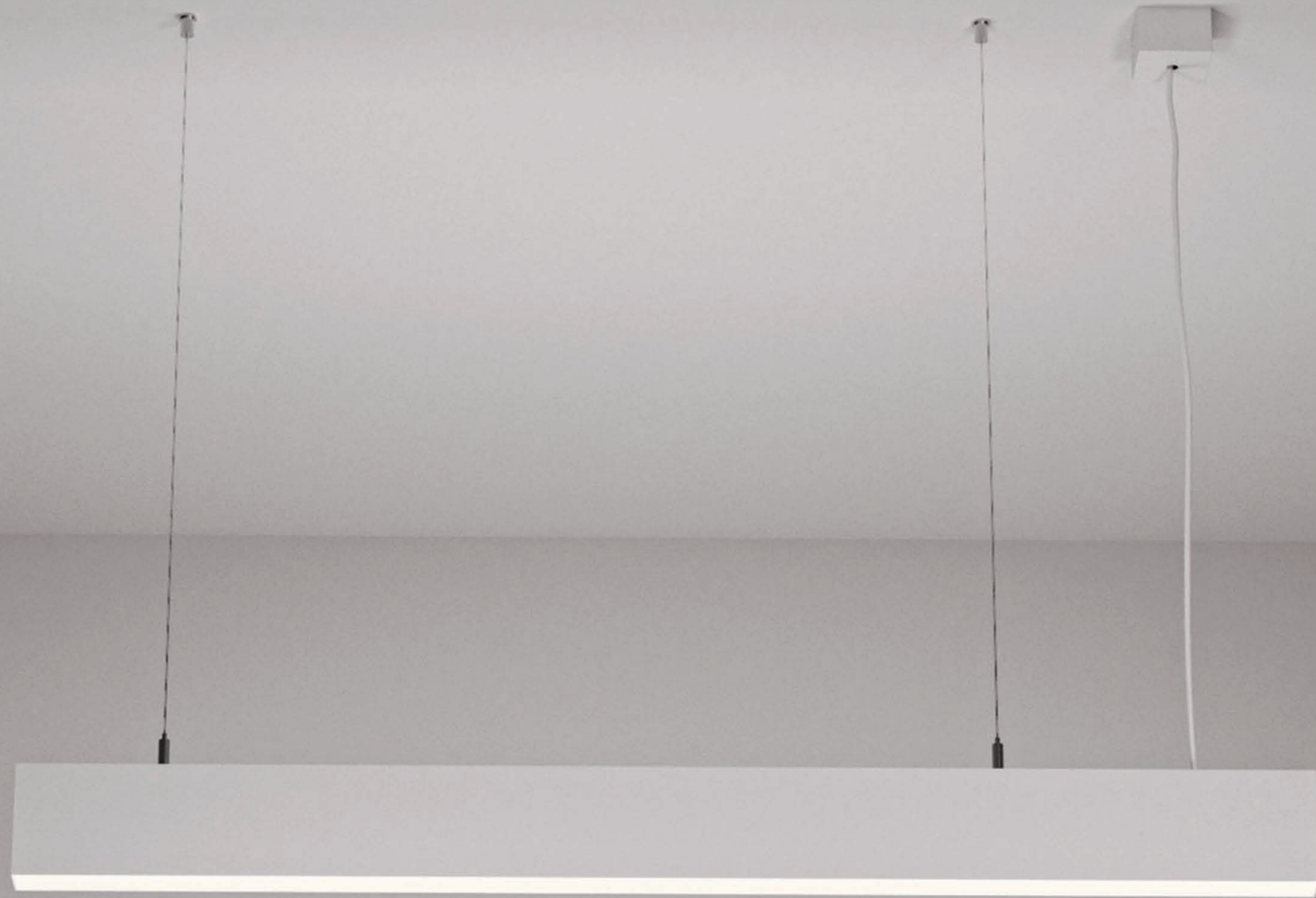

Sira P 4090

Linear Light

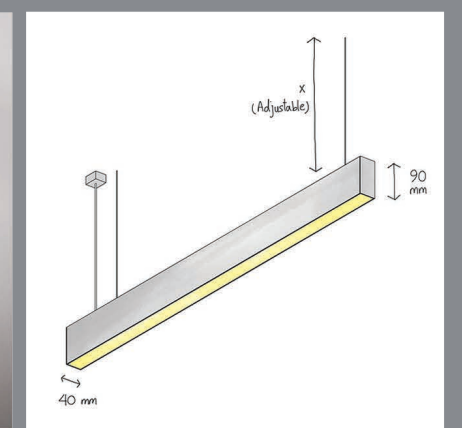
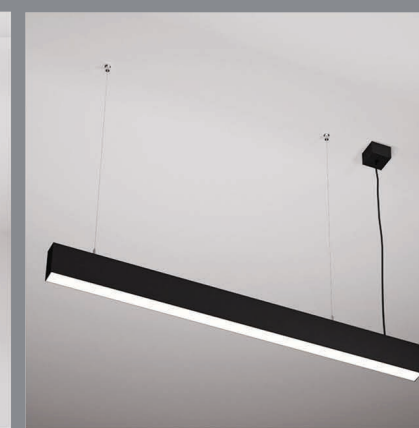
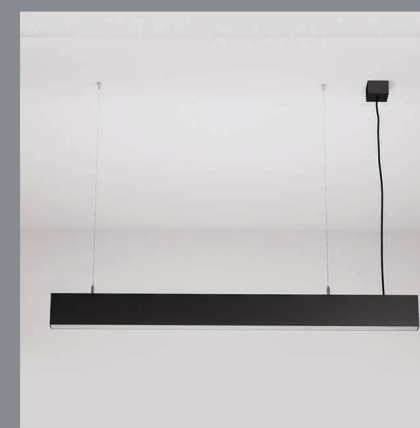

CODE	F422
Light source	LED
Power (W)	30 / 50*
luminous flux (lm)	4000
Color Rendering (Ra)	>80
Color Temperature (K)	3000 4000**
Body Color	White Black

*114 Cm : 35W / 168Cm : 50W

**Customized body colors and other color temperatures (CCTs) are available upon request



2.3 kg/m



127Ø x 100 cm

Supply Voltage:

220-240 Vac, 50Hz

Driver:

DALI | Dimmable version available upon request

Recommended Applications:

Residential | Office | Shop





▲ Charisma Holding / Dash Studio Office



Sira P 4090

Light distributions

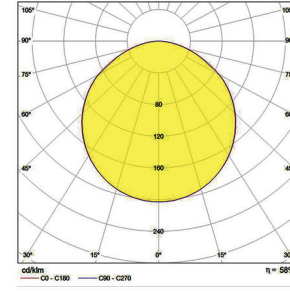

Wide (W)

Accessories

Optional

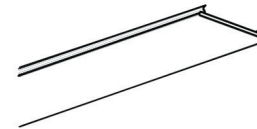

Solid Aluminium Cover
Order Code:
 White: 2420215106
 Black: 2420115106

Optional

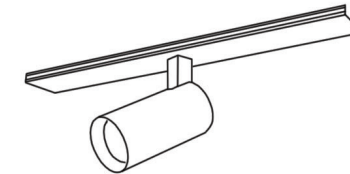

Merbora Micro
 Refer to page 350

Order code table

Body Color	3000K ●	Length (cm)	4000K ●	Body Color
White	F422W3530W	114	F422W3540W	White
	F422W5030W	168	F422W5040W	

Body Color	3000K ●	Beam Angle	4000K ●	Body Color
Black	F422B3530W	114	F422B3540W	Black
	F422B5030W	168	F422B5040W	

The above order table code is for standard lengths of 114 and 168 cm. To order other lengths, than standard shapes, please refer to our sales support team to help you.